

UNIVERSAL LOW VOLTAGE LED DIMMERS AMS - CG SERIES

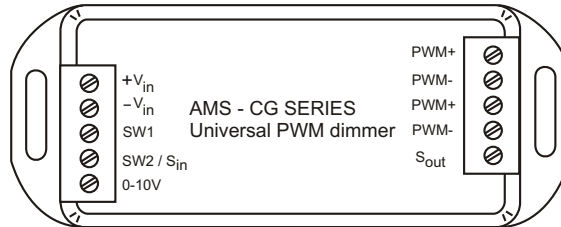

Description

AMS - CG series universal PWM dimmers are designed for smooth, flicker-free dimming of all constant voltage LED modules, including MR16 bulbs as well as 12V/24V Incandescent/Halogen bulbs

AMS -CG series dimmers are ideal LED dimmers for any application which calls for low voltage DC lighting for home as well as commercial and industrial applications. It can be used in recreational vehicles (RV), mobile homes and other large vehicles, such as buses and trucks where negative connection is connected to the common ground / chassis.

AMS - CG series dimmers include several protection features against common wiring/lamp malfunctions that can protect the installation and can be powered from DC power supply or batteries. This makes them ideal for use in marine environment such as ships, boats, yachts, sailboats and boat homes.

Features

- Smoothly dims any LED including hard to dim MR16 and G4 lamps
- Can be connected in common ground configuration where negative wire is absent (negative is connected to chassis)
- Excellent dimmer for 12V/24V Incandescent/Halogen bulbs as well
- Superior safety features including Overheating, No-load, Overload and Short circuit protection with auto restart
- Can be controlled with a variety of input devices including regular wall switches
- Simple synchronization of multiple units for controlling larger loads
- Non-volatile memory for dimmer output setting
- Compact housing
- High frequency PWM delivers flicker-free lighting at any level
- Minimum brightness adjusted with potentiometer
- High efficiency, low power consumption
- Safe and reliable screw terminals

Applications

- Nautical lighting
- RV / caravan lighting
- Low voltage lighting
- Applications when high reliability and safety of installation is needed
- Dimming of MR16, MR11, G4 and other LED lamps with integrated current controller
- Dimming of incandescent low voltage bulbs
- Dimming of any 12/24V DC constant voltage LED module such as:
Flexible and Rigid Strips, Rope Light, Rigid Light Bars, Under-cabinet Lights etc.

Specifications

TECHNICAL DATA	AMS-500-CG	AMS-850-CG	AMS-1200-CG
Supply input voltage range nom:	12 - 24 V DC	12 - 24 V DC	12 - 24 V DC
Supply input voltage (min - max):	6 - 30 V DC	6 - 30 V DC	6 - 30 V DC
Supply Input current:	5A	8.5A	12A
Output current max:	5A	8.5A	12A
Output load max:	60W@12VDC / 120W@24VDC	100W@12VDC / 200W@24VDC	144W@12VDC / 288W@24VDC
Control voltage:	1-10 V DC (0V - OFF)		
Control current max:	0.1mA		
Control:	0-10 V controls, Pot 100K Ohm, Dry Contact, Open collector		
Dimming mode:	PWM		
Operating frequency:	390 Hz		
Dimming range:	0-100%		
Dimming resolution:	65 000 steps		
Temperature range:	0 °C to +50 °C		
No-Load proof:	Yes		
Short circuit protection:	Yes, automatic shutoff, reversible		
Overload protection:	Yes, automatic shutoff, reversible		
Overheating protection:	Yes, reversible		
Input and output connections:	Screw terminal for wire 2mm ² (AWG 14) max.		
Housing dimensions (W x D x H):	40mm x 96mm x 20mm (1.5" x 3.75" x 0.75")		

Dimensions

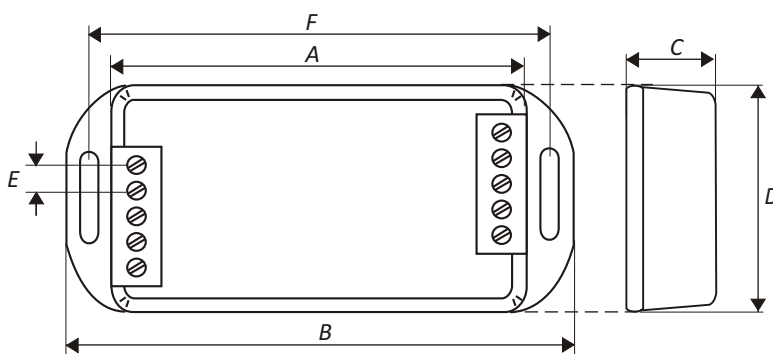

A (top housing length)	80 mm (3.15")
B (overall length)	96 mm (3.75")
C (height)	20 mm (0.75")
D (width)	40 mm (1.5")
E (connector pitch)	5 mm (0.2")
F (mounting hole pitch)	88 mm (3.5")

Installation

Connect the unit according to the control signal used (see connection diagrams below).

A unit can be mounted using two screws, double-sided tape or cable ties.

Sufficient heat dissipation of the device needs to be ensured. The ambient temperature must not exceed 50°C.

Power supply and load wires should have a sufficient diameter to minimize a voltage drop across the wires. If the voltage drop is too large, flickering of the lights and unstable operation is possible.

When long supply wires are used, it is recommended that a buffering capacitor of several 10 000uF (low ESR type) of appropriate voltage is used. The capacitor should be connected to the dimmer power supply input. Using a buffering capacitor will also filter and significantly decrease RFI emitted from supply wires.

Installation diagrams

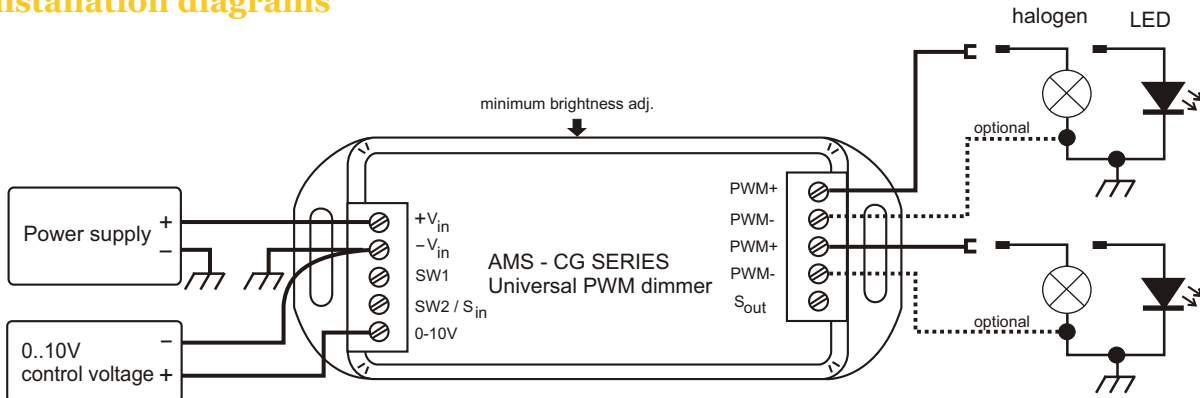

Wiring diagram for 0-10V control

NOTE1: both sets of PWM outputs are internally connected in parallel

NOTE2: negative connection can be routed through common ground (metal chassis) or via negative wire

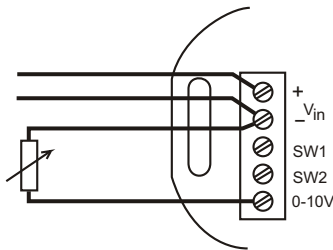

potentiometer control

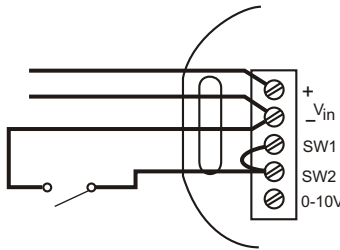

single switch control

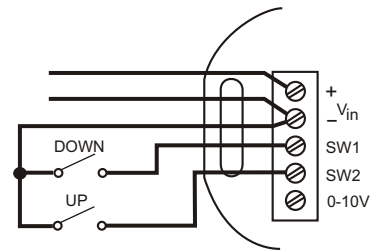

UP/DOWN switch control

INSTALLATION CONSIDERATIONS:

Power should be turned off during installation.

All connections should be secure, connector screws should be tightened.

After connecting the wires, turn the power on. Set the dimmer to the lowest setting. Using minimum brightness control trimmer, set the desired minimum brightness.

INPUT SIGNAL CONSIDERATIONS:

If using 0-10V control, make sure that the negative wire of the 0-10V control is not shared (take the same path) with power negative. The 0-10V negative should be connected as close as possible to the dimmer.

Wires (especially negative wires) should be connected in such way to avoid large ground loops.

If ground loops can't be eliminated, a SDU signal conditioning unit should be used (see SDU signal conditioning unit for connection diagrams).

Source of 0-10V control signal should be stable.

OUTPUT CONSIDERATIONS:

Output wires should be as short as possible. If possible, connect the dimmer close to the load.

If mounting the dimmer close to the load is not possible, make sure that positive and negative load wires do not form a large loop area. Load wires should run as close as possible to reduce EMI.

For further reduction of EMI, positive and negative load wires can be twisted or shielded and grounded cable can be used.

Power-on output state selection

When the dimmer is powered on or when it loses power for a short time it sets its output to the power-on state. This state depends on the control used. If controlled by 0-10V voltage or 100k potentiometer the power-on state is set by voltage/resistance on its 0-10V input. If the dimmer is controlled by a momentary switches the power-on states can be selected by following connections:

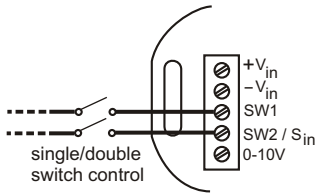

Dimmer goes to the "last set state" stored in the non-volatile memory at power on/power loss.

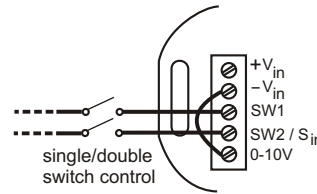

Dimmer remains "off" at power on / power loss

Synchronizing multiple units

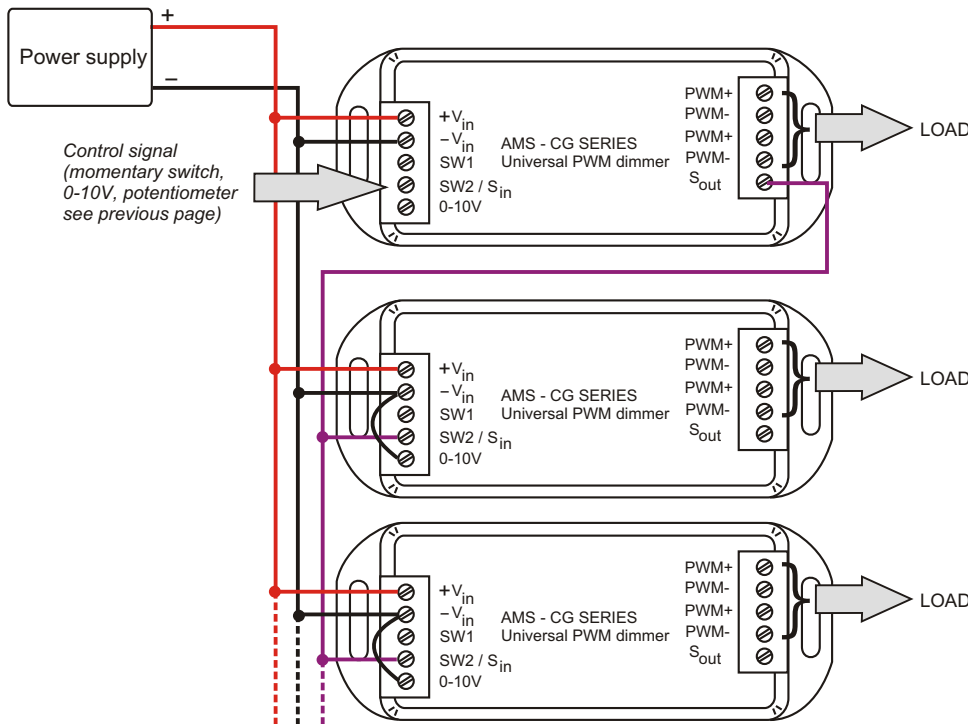

Several AMS - CG series dimmers can be synchronized to:

- **control larger load.** If loads, larger than a single dimmer capacity need to be controlled, several dimmers can share the load. In theory unlimited number of units can be synchronized, but in practice wiring limits connection of 5-10 units.
- **control multiple dimmers with single push button control.** When control switch is connected to multiple dimmer unit inputs, dimmers can become unsynchronized due to small timing differences between units, even if they receive the same switch control. When multiple units are synchronized they can be controlled by a single switch control
- **control multiple dimmers with single potentiometer.** Potentiometer can control only one unit. When multiple units are synchronized they can be controlled by a single potentiometer.

NOTE: Above connection diagram shows a single power supply powering all dimmers. Each dimmer can use its own power supply, but ground (negative wire) of all power supplies must be connected together

NOTE: It is possible to mix different types of AMS - CG series dimmers in above connection

IMPORTANT: Outputs of separate dimmers should not be connected in parallel. Each should control its own set of lamps.